

Data Sheet



Article number: 02150000061

Description: Sealing Clamp S 61 W1

Measures

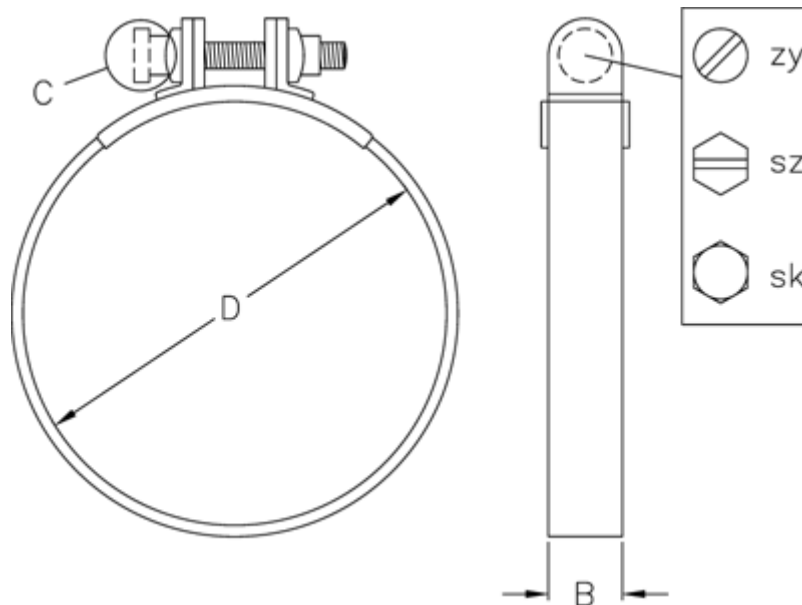

C (screw type) = SZ

Diameter D = 61

Width B = 20